



COLLECTION
BATHS
AND
SHOWERS



THE BEST MOMENT OF THE DAY.

Maybe you've spent hours in a successful meeting,
or played a gruelling five-a-side football match with your friends.

Perhaps you've been on your feet all day shopping,
or out travelling to explore wonderful new locations.

All these things require effort.

These are both exciting and small adventures of everyday life.
The ones that give you real pleasure, purpose and a feeling of fulfilment.

As great as they are they can also be tiring.
Now is the time to turn an exceptional or a tiring day into a perfect one.

The moment that refreshes you to face new challenges tomorrow.

Your bath Jacuzzi®.

It's not just a matter of hydromassage technology,
we're talking about real science that produces authentic, all-round well-being.

It's the best moment of the day.





**WHEN
HYDROTHERAPY
IS A 65-YEAR STORY
THAT BELONGS
TO HISTORY.**

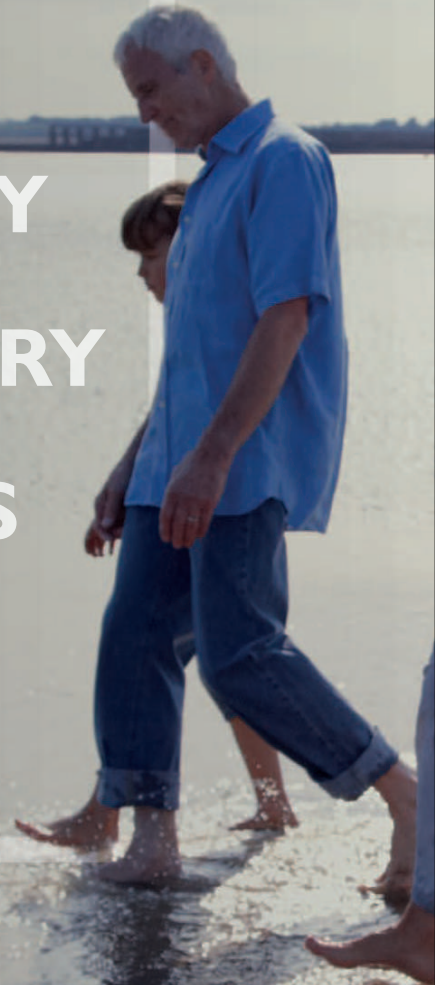



FIND OUT HOW IT
ALL STARTED



BRAND STORY

When the seven Jacuzzi brothers emigrated from Italy to the United states, they had no idea that a pump they designed for orchards would revolutionise hydrotherapy in the home. And while the family's critical need to change the life of a child triggered this therapeutic invention, a desire for wellness pioneered an industry.



ROMAN BATH
the first whirlpool bath in the world.



1968

J-TWIN
the first Jacuzzi® model to combine the comfort of a bath with the convenience of a shower.



1992

MORPHOSIS
top design, top technology: launching of the first line designed by Pininfarina.

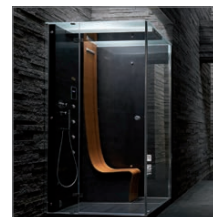

2004

1956

J-300®
the first portable device to create a hydromassage in a bath.

1986



DESIGNER COLLECTION
the first Jacuzzi® collection made entirely in Italy, from design to production.

1993

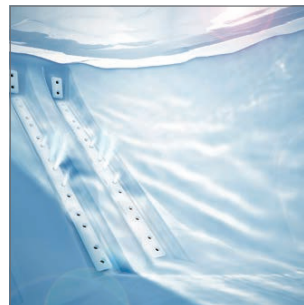

A SHIATSU MASSAGE IN WATER
Jacuzzi® develops new, exclusive technology and launches the first shiatsu hydromassage system in a bath.

2006



AURA
a new range of tubs that can be customised with wood, marble and other precious materials.



AQUASOUL and AQUASYSTEM®
 Innovation transforms hydromassage into noiseless wellness while technology fully customises its functions.



2008

TARGETPRO™
 flow-rate, intensity, direction, slant: hydromassage now offers unprecedented customisation heights.



2012

ARGA®
 The ARGA® design is fluid and minimal to complement the gentle, soft and enveloping Swirlpool® bathing experience.



2019

2010



FRAME
 the shower that celebrates total wellness in a contemporary design frame: an authentic private spa with shiatsu hydromassage and steam bath options.

2014



MUSE
 the art of a masterly Shiatsu massage paired with the formal elegance of a freestanding bath.

2020



XYZ⁺
 the new Jacuzzi® shower system designed to fit every space



DISCOVER
 OUR STORY

A woman with her hair in a ponytail is shown in profile, sitting in a meditative pose on a dark, rocky cliff edge. She is wearing a white tank top and dark pants. Her hands are resting on her knees in a mudra. The background is a clear blue sky with some clouds near the horizon. A large, light blue rectangular frame is superimposed over the scene, containing the text.

**WELLNESS
CAN NOW BE
MOULDED AROUND
YOUR DESIRES.
FIND OUT HOW.**



Whatever your idea of wellness may be, Jacuzzi® has it for you. But if you really can't wait to find your perfect bath or shower, simply choose what you could never do without. Your wish will come true straight away.

“Water heals.”

This statement belongs to Sebastian Kneipp, a 19th century Bavarian priest who laid the foundations of modern hydrotherapy, a healing method based on many ways of applying water.

In particular, hydrotherapy uses full or partial showers or baths to warm or refresh the body.

The healing action is achieved thanks to the temperature of the water. The purpose of this treatment is to stimulate the body's natural self-healing mechanisms through alternate applications of hot and cold water.

The first reaction, which is skin deep, is then transmitted to tissues deep inside the body that are connected to the surface by means of the nervous system. Although a hot bath may be exhilarating at first, its aftermath may be stressful for the body. The water temperature must be adapted to the duration of your bath. Above 37°C water is classified as hot; at 40°C it is very hot and over 46°C it becomes unbearable for more than a few seconds.

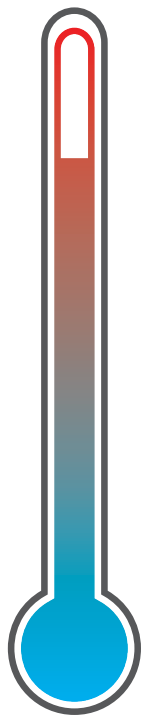

40°C Hot water
up to Very relaxing, induces drowsiness and sleep.

34-38°C Water at body temperature
up to Reduces tension and favours sleep.
Sweating, which cleanses the skin and body and helps to eliminate lactic acid, is stimulated by adding bath salts.

33°C Lukewarm water
up to Helps eliminate water retention.

27°C Cool water
up to Alleviates fatigue.

18°C Cold water
up to Aids muscle recovery after physical exertion.

Hydromassage designed to be the best in the world.

There must be a reason behind the famous name Jacuzzi® has made for itself as the best hydromassage in the world. In fact, there are plenty of reasons: the TargetPro™ jets for instance, developed to deliver a targeted massage to each body area thanks to a perfect mixture of air and water.

Both their power and direction can be fully adjusted for an effective massage, no matter what your requirements may be.

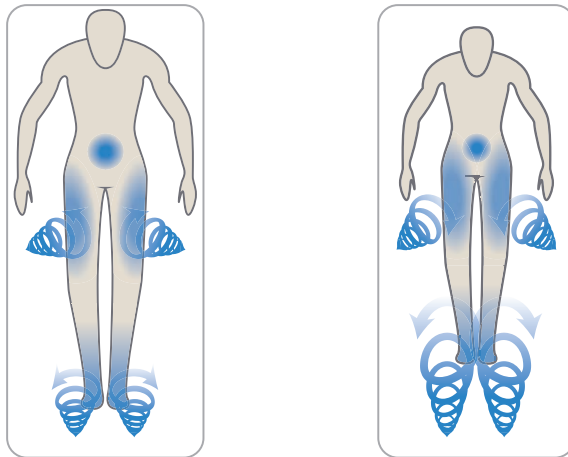
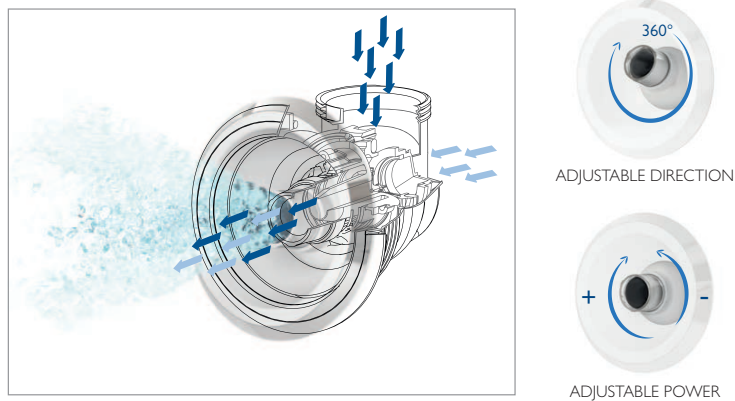

Change the direction of your jets through 360 degrees to treat specific body areas with a perfect mixture of air and water. Rotate the jets to adjust their power or turn them off altogether.



WATCH THE VIDEO

Just the right temperature for wellness.

A hydromassage is truly perfect when it strikes the right balance between the temperature of the water and the duration of the bath. Heat is the ideal ally of psychological and physical relaxation but it can also cause excess stress.

The general rule is: the higher the water temperature - that should never exceed 40°C - the shorter the hydromassage.

Recommended temperatures and durations:



38°C - 40°C
10 minutes



36°C - 38°C
15 minutes



34°C - 36°C
20 minutes

As well as whirlpool baths, Jacuzzi® also offer a wide range of non-jetted baths. Total immersion in water at various temperatures has beneficial effects on the mind and body. You can even complete each treatment with essential oils and salts for a really unbeatable wellness experience.

Shower and steam bath. Your wellness centre.

Raindrop, Scottish, cascade...there are all sorts of showers but those produced by Jacuzzi® can easily be summed up in two words: wellness centre. The adjustable jets, that can be directed to any body area, deliver the benefits of an authentic, relaxing and regenerating treatment for the mind and body. Jacuzzi® hydrotherapy has been designed to satisfy all your requirements: it firms the skin and keeps it supple, promotes proper blood circulation and even fights cellulite.

You can take a purifying steam bath, cleanse your skin in

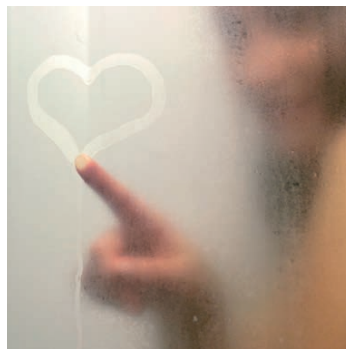
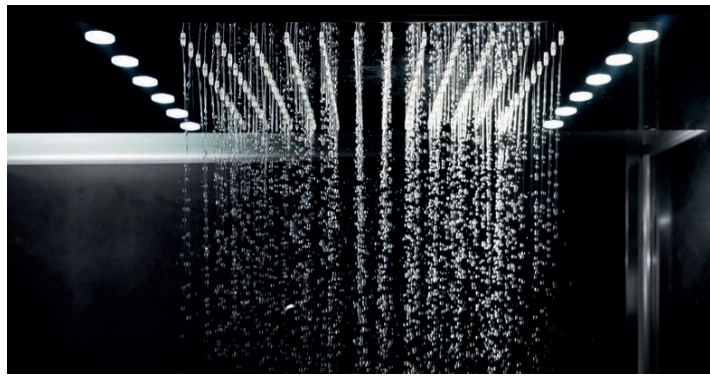

depth, boost your respiratory system and take off again with renewed energy. The steam bath, also called “hammam”, uses dry steam and differs from a sauna because it requires an environment saturated with hot air at 40-50°C and 100% humidity. This treatment strengthens your immune system, speeds up your metabolism and improves blood circulation. When paired with aromatherapy it delivers awesome benefits for your mind and body. In other words, wellness is just a Jacuzzi® away. And we keep our promises.

The shape of wellness: Swirlpool®.

The ARGA® design is fluid and minimal to complement the **gentle, soft and enveloping Swirlpool® bathing experience.** Different styles and installations offer adaptability. The design offers a warm, oval, reassuring shape - an ancestral nest, of sorts - born to eliminate the perception of time and lull the bather with **swirls of water and integrated jet lighting.**



Illumatherapy™ features infuse the water with a warm and magic glow. The touch pad complements the bath with a modern design style and three control icons. It serves as a meaningful ARGA® design element, by blending elegance, performance and comfort.

Dive in time: ARGA®.

Time and water have much more in common than expected - they both flow in harmony within the universe of ARGA®, the revolutionary Jacuzzi® bath experience intended to redefine the world of personal wellness.

With the **new Swirlpool® technology**, the bath experience emulates that of an enveloping, heartfelt embrace, or that of full immersion in a silent creek, all while deeply connected with nature. Thanks to the delicate swirls created by the colored water jets and the constant bath water temperature, the ARGA® experience becomes multi-sensory and fully immersive.

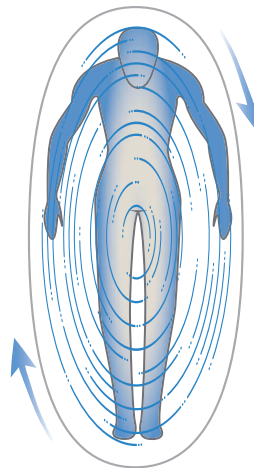

Swirlpool technology®

SWIRLPOOL®



SWIRLPOOL®

The bath experience emulates that of an enveloping, heartfelt embrace, or that of full immersion in a silent creek, all while deeply connected with nature.

HYDROMASSAGE



SHIATSU

A set of relaxing jets positioned along your back deliver a soothing, toning massage that also relieves pain.



TARGETPRO™

The many directions to which this jet can be adjusted produce a fully customisable hydromassage which, as well as flow, intensity and power, can be set to suit your needs.



TWIRL

The jets used for the back massage have a rotating action that gently massages the back, easing muscular tension.



TONIC

Multi-directional jets deliver a focused, vigorous treatment that uses a perfect mixture of air and water at the right intensity.



PURE AIR®

Lively or velvety smooth, this air bubble massage helps add oxygen to the water, revitalizing the skin and giving it a clearer appearance.

PROGRAMMES



AQUASYSTEM®

SILENCE

Dissolves muscular tension and strain in blissful silence, favouring complete relaxation.



RECHARGE

This sequential hydromassage gradually increases in intensity to recharge and tone your body, dissolving contractures and stiffness.



RELAX

This hydromassage promotes deep psychological and physical well-being because it is delivered at a slow, harmonious pace that matches the rhythm of your breathing.



REBORN

A blend of gentle and toning properties. The water pampers you in a beneficial embrace.



RAINBOW AND COURTESY LIGHT

This is an authentic chromotherapy treatment for total wellness that involves the mind as well as the body. Doubles as a courtesy light.



SOUND SYSTEM

Your favourite music offers you an even deeper wellness experience.



HEAT

This system keeps the water temperature constantly perfect.



CLEAN SYSTEM

Automatically disinfects and sanitizes your whirlpool bath.

SHOWER AND STEAM BATH



STEAM BATH

All the regenerating heat of steam cleanses you deep down and gives you a feeling of authentic well-being. For a totally renewed you.



SHIATSU

A set of relaxing jets positioned along your back deliver a soothing, toning massage that also relieves pain.



DORSAL HYDROMASSAGE

An unparalleled combination of toning and firming energy stimulates blood circulation, melts away tension and gives you a new lease of life.



EMOTIONAL SHOWER

An enthralling interplay of lights and water contributes to pure relaxation. Just choose the function you prefer.



NEBULIZATION

A mist of regenerating and beneficial microjets refresh your body.



CASCADE SHOWER

A constant, powerful jet relaxes the muscles most targeted by fatigue.

PROGRAMMES



AROMATHERAPY

This fascinating sensorial experience turns every breath into an emotion.



SOUND SYSTEM

Your favourite music offers you an even deeper wellness experience.



DESCALER

Removes limescale from the steam bath heater.



**FOCUSING
ON YOURSELF.**

M E



Dedicated to those who live life in the singular. To those who dedicate the right amount of time to themselves and to achieving physical and psychological well-being or to getting back into perfect shape after having played a sport. To those who plan wellness and nothing else. To those who treat themselves to quality time, Jacuzzi® dedicates a range of baths they can really relax in and a line of showers in which they can benefit from water, colours, music and steam in lots of different ways. From the ultimate in wellness, the best technology and design to suit all your needs.

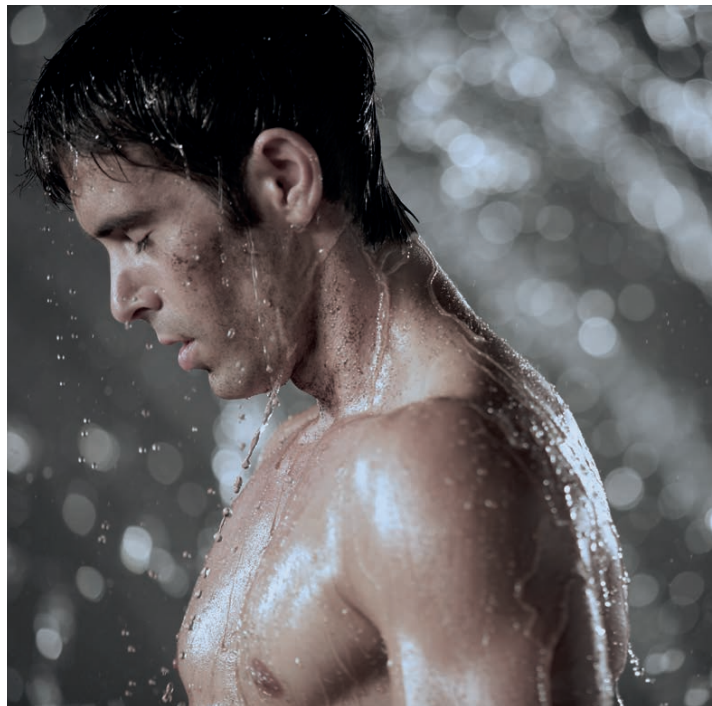

A full-page photograph of a family—a man, a woman, and a young child—running barefoot on a sandy beach. They are captured in motion, running from left to right. The scene is set during sunset or sunrise, with long shadows cast on the sand and waves visible in the background. The overall mood is joyful and active.

**THE PLEASURE
OF WELLNESS,
THE BEAUTY
OF SHARING.**

W E



From the heart of the best Jacuzzi® know-how comes a range of products designed to transform your love for wellness into the perfect time for togetherness. Enjoy precious and really unforgettable moments while relaxing with the whole family. Help your children make the amazing discovery that wellness can be fun. Jacuzzi® baths and showers coax your bodies into total relaxation while really user-friendly controls let you concentrate fully on the magical pleasures you are experiencing.





A BATH THAT CAN BE CUSTOMISED TO CREATE YOUR OWN PERSONAL SPA.

AURA UNO CORIAN®

A U R A

Legendary Jacuzzi® wellness in a context of refined beauty. Aura's frame can be fully customised to suit its surroundings: choose from our exclusive materials or create it from scratch. Perimeter lighting turns each massage into an awesome experience while the overflow rim and the removable pillow, moulded to suit the shape of your neck, guarantee absolute comfort. A bath designed to soak your whole body in.



Overflow rim



Perimeter lighting



Raised Aura Corner seat



TARGETPRO™



TWIRL



RAINBOW AND
COURTESY LIGHT







HEAT

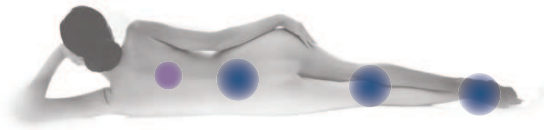

CLEAN
SYSTEM

AURA
designed by Carlo Urbinati



	 AURA - UNO - CORNER 140	 AURA Corian® - UNO - CORNER 140	 AURA - PLUS - CORNER 160	 AURA Corian® - PLUS - CORNER 160	
BENEFITS	MASSAGE AREAS				
	● Back	✓	✓	✓	✓
	● Loins	✓	✓	✓	✓
	● Legs	✓	✓	✓	✓
	● Feet	✓	✓	✓	✓
	PROGRAMMES				
	Rainbow and courtesy light	✓	✓	✓	✓
	Heat		✓	✓	✓
	Clean System (automatic)	✓	✓	✓	✓
	FEATURES	● TargetPro™ jets	5	5	6
● Twirl jets		3	3	7/10	7/10
Air adjustment		✓	✓	✓	✓
Touch controls			✓		✓
Control Panel		✓		✓	
Safety starter - Safe start with water only		✓	✓	✓	✓
Removable pillows		✓	✓	✓	✓
Perimeter lighting			●		●
Deck mount tapware		●	●	●	●
✓ Standard ● Optional					

FRAME MATERIALS

CORIAN®



glacier

STONE



marble white carrara



granite absolute black



Piasentina stone

WOOD



teak



wengè

PANEL MATERIALS

WOOD



teak



wengè



AURA

AURA PLUS WOOD
frame finishing: Teak

aura uno stone/wood

180 x 90 x 66 H cm
left version only

net weight:
stone 133 kg - wood 100 kg
depth of tub to overflow 42 cm
length at fittings 133 cm
maximum seat width 60 cm
average water consumption for hydromassage 275 l



LEFT VERSION

aura uno Corian®

185 x 95 x 66 H cm
left version only

net weight 131 kg
depth of tub to overflow 42 cm
length at fittings 133 cm
maximum seat width 60 cm
average water consumption for hydromassage 275 l



LEFT VERSION

aura corner stone/wood

140 x 140 x 60 H cm
left version only

net weight:
stone 155 kg - wood 90 kg
depth of tub to overflow 39 cm
length at fittings 117 cm
maximum seat width 68 cm
average water consumption for hydromassage 220 l

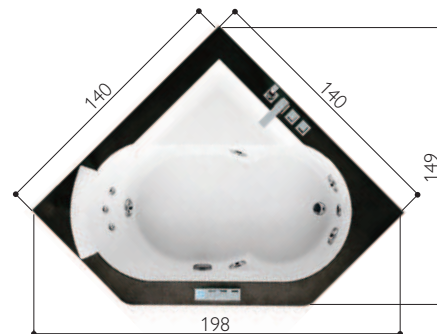

LEFT VERSION

aura corner Corian®

144 x 144 x 60 H cm
left version only

net weight 115 kg
depth of tub to overflow 39 cm
length at fittings 117 cm
maximum seat width 68 cm
average water consumption for hydromassage 220 l

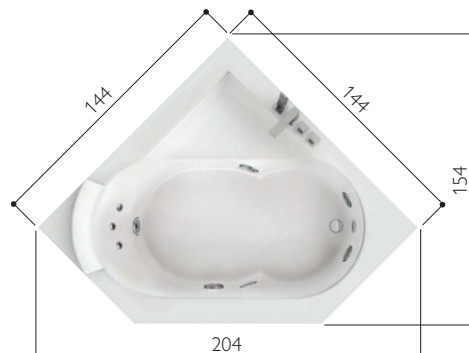

LEFT VERSION



A U R A

AURA CORNER 140 WOOD
frame finishing: Teak

aura plus stone/wood

180 x 150 x 66 H cm
only version

net weight:
stone 200 kg - wood 125 kg
depth of tub to overflow 42 cm
length at fittings 130 cm
maximum seat width 110 cm
average water consumption for hydromassage 530 l

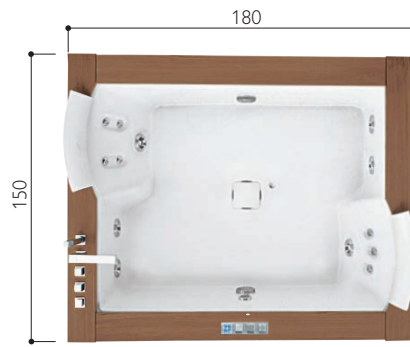

aura plus Corian®

185 x 155 x 66 H cm
only version

net weight 165 kg
depth of tub to overflow 42 cm
length at fittings 130 cm
maximum seat width 110 cm
average water consumption for hydromassage 530 l

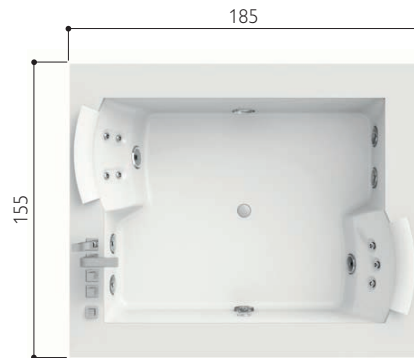

aura corner stone/wood

160 x 160 x 60 H cm
only version

net weight:
stone 191 kg - wood 116 kg
depth of tub to overflow 39 cm
length at fittings 130 cm
maximum seat width 66 cm
average water consumption for hydromassage 320 l

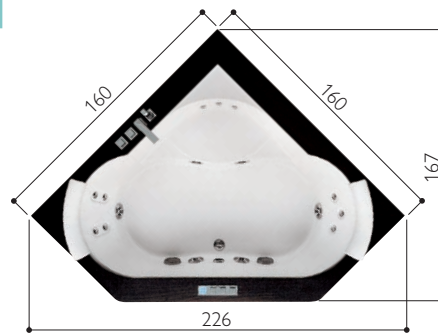

aura corner Corian®

164 x 164 x 60 H cm

net weight 144 kg
depth of tub to overflow 39 cm
length at fittings 130 cm
maximum seat width 110 cm
average water consumption for hydromassage 320 l

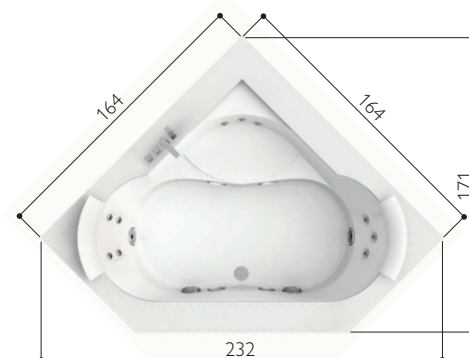



A U R A

AURA CORNER WOOD
frame and panels finishing: Wengè

**CHAISE LONGUE AND TOTAL BODY MASSAGE.
MAKE YOURSELF COMFORTABLE AND ENJOY WELL-BEING.**



SHARP EXTRA

S H A R P

The ultimate in relaxation in a modern setting. Sharp delivers an amazing total body massage in a tub with a contemporary design, conceived to adapt to any space and offer unsurpassable comfort. The panels can be customised in various finishes to coordinate with the rest of the room. The incredibly soft pillow and the comfortable deck turn any moment into pure relaxation while super-easy access to the bath adds safety to your enjoyment.



Chaise longue



Soft pillow

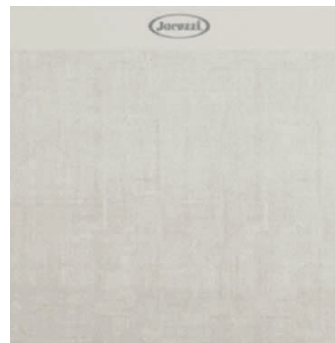

Combinable panels



TARGETPRO™



TWIRL



AQUASYSTEM
SILENCE



AQUASYSTEM
RECHARGE



AQUASYSTEM
RELAX



AQUASYSTEM
REBORN



RAINBOW AND
COURTESY LIGHT



HEAT



CLEAN
SYSTEM

S H A R P
designed by Carlo Urbinati

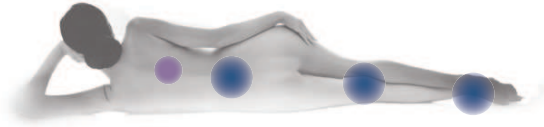

**SHARP
70, 75**



**SHARP
DOUBLE**



**SHARP
EXTRA**

		RAINBOW + CLEAN SYSTEM	AQUA- SYSTEM®	RAINBOW + CLEAN SYSTEM	AQUA- SYSTEM®	RAINBOW + CLEAN SYSTEM	AQUA- SYSTEM®
BENEFITS	MASSAGE AREAS						
	● Back	✓	✓	✓	✓	✓	✓
	● Loins	✓	✓	✓	✓	✓	✓
	● Legs	✓	✓	✓	✓	✓	✓
	● Feet	✓	✓	✓	✓	✓	✓
	PROGRAMMES						
	Aquasystem®						
	Silence		✓		✓		✓
	Recharge		✓		✓		✓
	Relax		✓		✓		✓
Reborn		✓		✓		✓	
Rainbow and courtesy light	✓	✓	✓	✓	✓	✓	
Heat		✓		✓		✓	
Clean System (automatic)	✓	✓	✓	✓	✓	✓	
FEATURES	● TargetPro™ jets	4	4	5	5	3	3
	● Twirl jets	4	4	10	10	22	22
	Air adjustment		✓		✓		✓
	J.touch remote control		✓		✓		✓
	Touch controls	✓		✓		✓	
	Safety starter - Safe start with water only	✓	✓	✓	✓	✓	✓
	Removable pillows	✓	✓	✓	✓	✓	✓
	Drainage column with fill spout	●	●	●	●	●	●
	Deck mount tapware	●	●	●	●	●	●
	PANELS						
	Gypsum (HPL laminated)	●	●	●	●	●	●
	Stone grey (laminated)	●	●	●	●	●	●
	Oak (laminated)	●	●	●	●	●	●
Cement (laminated)	●	●	●	●	●	●	

PANEL MATERIALS

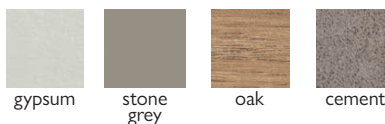



S H A R P

SHARP 75
panels Oak

sharp 70

170 x 70 x 57 H cm

left or right version

net weight 60 kg

depth of tub to overflow 40 cm

length at fittings 118 cm

maximum seat width 44 cm

average water consumption for hydromassage 162 l

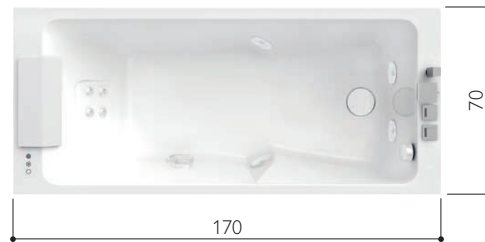

LEFT VERSION

sharp 75

170 x 75 x 57 H cm

left or right version

net weight 65 kg

depth of tub to overflow 40 cm

length at fittings 126 cm

maximum seat width 49 cm

average water consumption for hydromassage 180 l



LEFT VERSION



S H A R P

SHARP 75
panels Oak



sharp double

190 x 90 x 57 H cm
only version

net weight 72 kg
depth of tub to overflow 41 cm
length at fittings 110 cm
maximum seat width 60 cm
average water consumption for hydromassage 264 l



sharp extra

200 x 150 x 65 H cm
only version

net weight 127 kg
depth of tub to overflow 48 cm
length at fittings 118 cm
maximum seat width 60 cm
average water consumption for hydromassage 500 l





SHARP DOUBLE
finishing: Gypsum







SHARP DOUBLE
panels Gypsum



JUST TWENTY MINUTES IS ALL YOU NEED TO FEEL PERFECTLY REVITALISED.

ENERGY

This is the ideal bath for an energy boost. Chromotherapy turns on at the touch of a finger, making every second you spend in your bath even more special. Use it to create atmosphere when the bath is empty. Its minimalist lines make Energy perfect for any setting and, if you pair it with the Mix enclosure, you can benefit from a comfortable and roomy shower.



Touch controls you can really feel



Large pillow and backrest

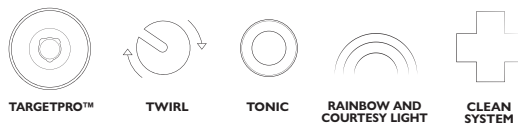

ENERGY
designed by EMO



ENERGY
160, 170, 180

BENEFITS	MASSAGE AREAS	BASE	RAINBOW + CLEAN SYSTEM
		<ul style="list-style-type: none"> ● Back ● Legs ● Feet 	✓
PROGRAMMES	Rainbow and courtesy light		✓
	Clean System (manual)		✓

FEATURES		
	BASE	RAINBOW + CLEAN SYSTEM
● TargetPro™ jets	2	2
● Twirl jets	2	2
● Tonic jets	2	2
Touch controls	✓	✓
Safety starter - Safe start with water only	✓	✓
Removable pillow	●	●
Courtesy light		✓
Fill system	✓	✓
Deck mount tapware	●	●
Column with fill spout	●	●
Click-clack waste	✓	✓
Panels		
white acrylic (front/side)	●	●
L-shaped in white acrylic	●	●

✓ Standard ● Optional

PANEL MATERIALS



white acrylic



energy 160,170

160 x 70 / 170 x 70 x 57 H cm
left or right version

net weight 57/62 kg
depth of tub to overflow 32 cm
length at fittings 117-127 cm
maximum seat width 47 cm
average water consumption for hydromassage 140/154 l



LEFT VERSION

energy 180

180 x 80 x 57 H cm
left or right version

net weight 70 kg
depth of tub to overflow 32 cm
length at fittings 137 cm
maximum seat width 57 cm
average water consumption for hydromassage 202 l



LEFT VERSION